

Making of a Large Accelerator (Indian Accelerator Program)

Shekhar Mishra

Fermilab



Outline



- **Introduction**
- **Why Accelerator**
- **Major Accelerators of the world**
- **International Linear Collider**
- **Indian Accelerator Program**
- **Summary**

Introduction



“It is an inherent obligation of a great country like India with its traditions of scholarship and original thinking and its great cultural heritage to participate fully in the march of science, which is probably mankind's greatest enterprise today.” Pundit Jawaharlal Nehru

- **There are many fundamental questions that we need to answer to Understand the Nature of Nature”**
- **Basic Scientific Research and Accelerator development is driving the development of advanced technologies.**
- **Accelerators have become an integral part of our life.**
 - **Medical treatment**
 - **Development of medicine**
 - **Development of material**

Large Accelerators: Crucial Questions



- What is the nature of the Universe and what is it made of?
- What are the Matter, Energy, Space and Time?
- How did we get here and where are we going?
 - Profound understanding of the fundamental particles and the physical laws that govern matter, energy, space and time: “Standard Model”
 - Only ~5% of the universe is made up of normal, visible matter described by the Standard Model.
 - ~95% of the universe remains a mystery

We have a scientific revolution at hand.

- Einstein's Dream of Unified Forces
 - Are there undiscovered principles of nature: New Symmetries, New Physics Laws?
 - How can we solve the mystery of Dark Energy?
 - Are there Extra Dimensions of Space?
 - Do all the forces become one?
- The Particle World
 - Why are there so many kinds of particles?
 - What is the Dark Matter? How can we make it in the laboratory?
 - What are neutrinos telling us?
- The Birth of Universe
 - How did the Universe come to be?
 - What happened to the antimatters?

Quantum Universe: THE QUESTIONS



Fermilab

	Tevatron	LHC	Linear Collider	NuMI / MINOS	ν Superbeams	BaBar	BTeV	JDEM	RHIC	Proton Decay
Undiscovered Principles? 1	X	X	X			X	X			
Dark Energy? 2		X	X					X		
Extra Dimensions? 3		X	X							
Unified Forces? 4			X							X
Why So Many Particles? 5	X					X	X			
Dark Matter? 6			X					X		
Neutrinos? 7				X	X					
Origin of Universe? 8		X							X	
Antimatter? 9					X	X	X			

Highest Energy Collider: Fermilab



Greatest window into new phenomena until LHC starts in 2008-9.



International Collaboration



CDF
11 Countries

D0
18 Countries

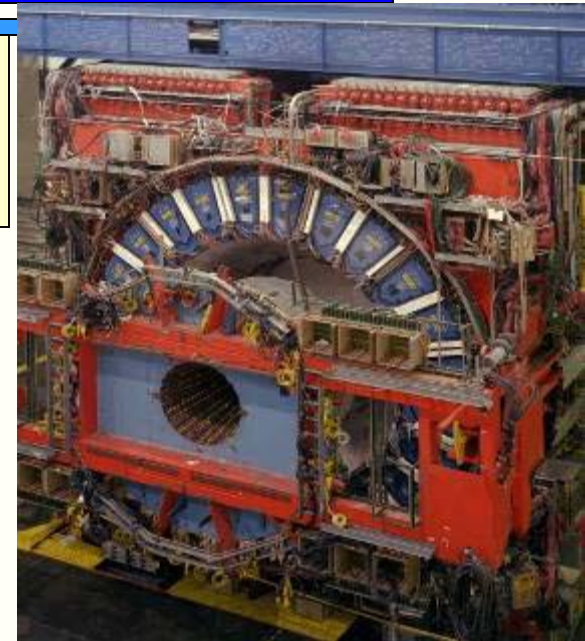

MINOS
6 Countries

CMS
36 Countries
JAS 2008



Accelerators and the Energy Frontier



Large Hadron Collider CERN – Geneva Switzerland



India has contributed significantly to the LHC.

Why e^+e^- Collisions ?



Next proposed large accelerator is an e^+e^- collider.

- elementary particles
- well-defined
 - energy,
 - angular momentum
- uses full Center Of Mass energy
- produces particles democratically
- can mostly fully reconstruct events

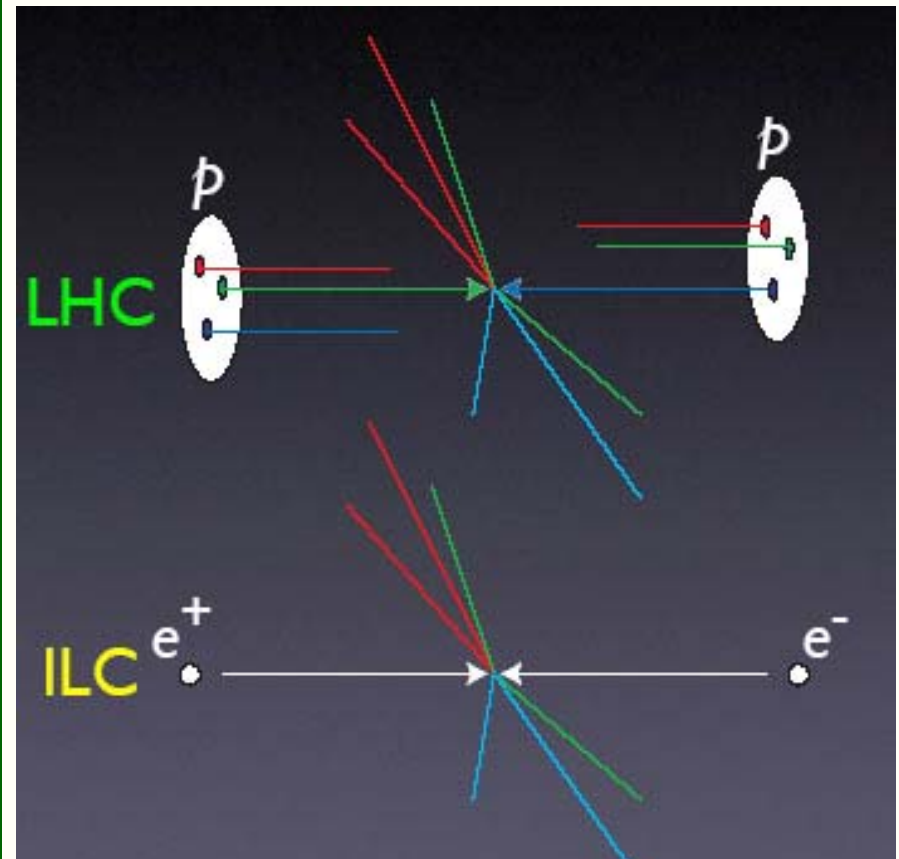

The International Linear Collider



The Baseline Machine (500 GeV)

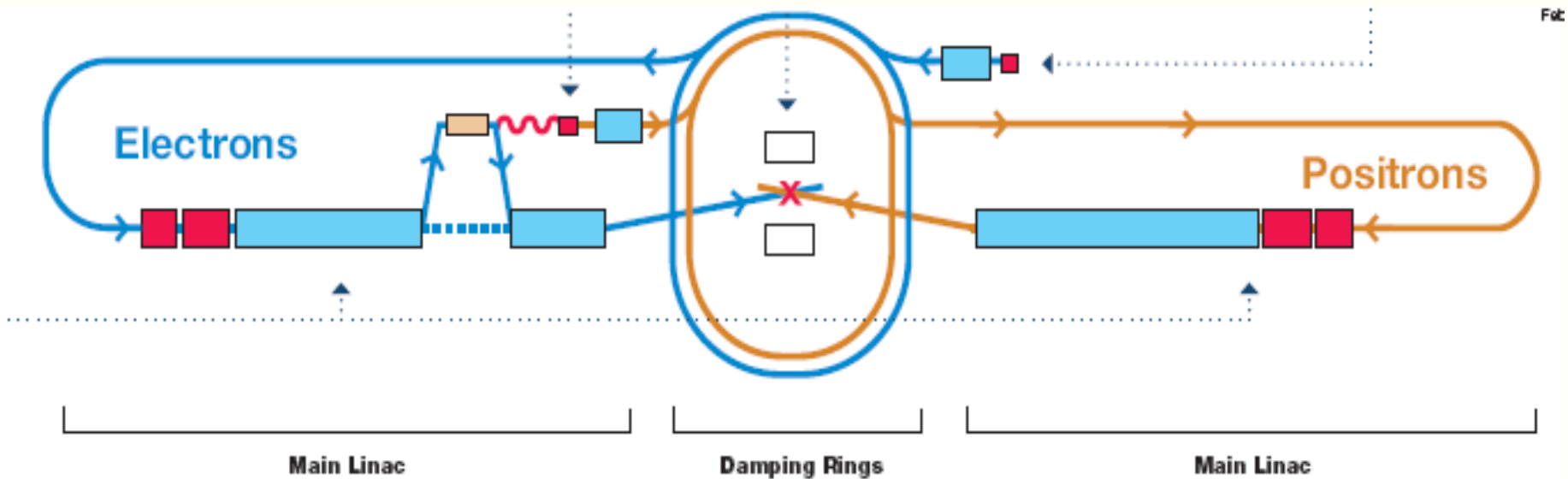

ILC is one of the most complex accelerators with considerable technical and management challenges.

Technical Challenge

- Accelerating Gradient 35 MV/m
- Electron Cloud effect in the positron ring
- Preservation of small emittance in long linac
- Collision of two small size (10s nanometer beams)

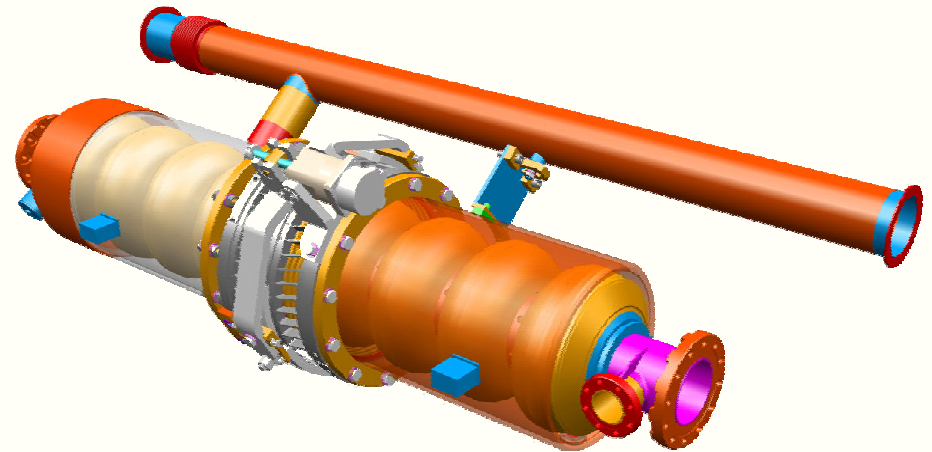
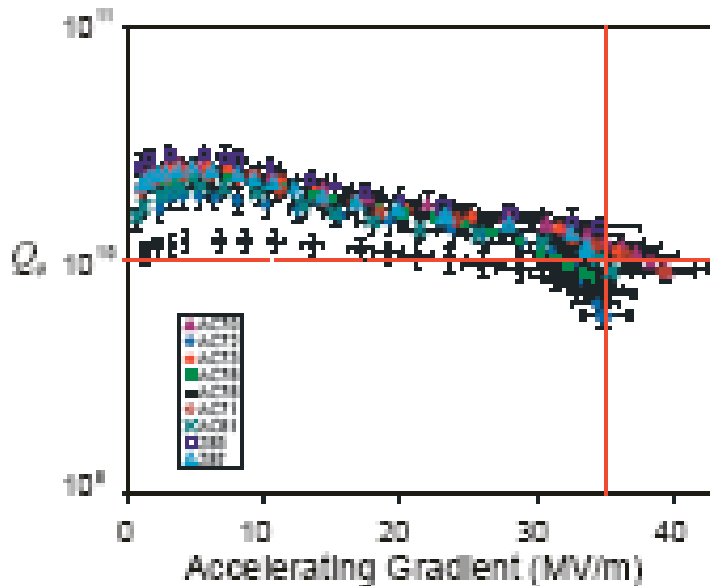

ILC Cryomodule 3-D Model

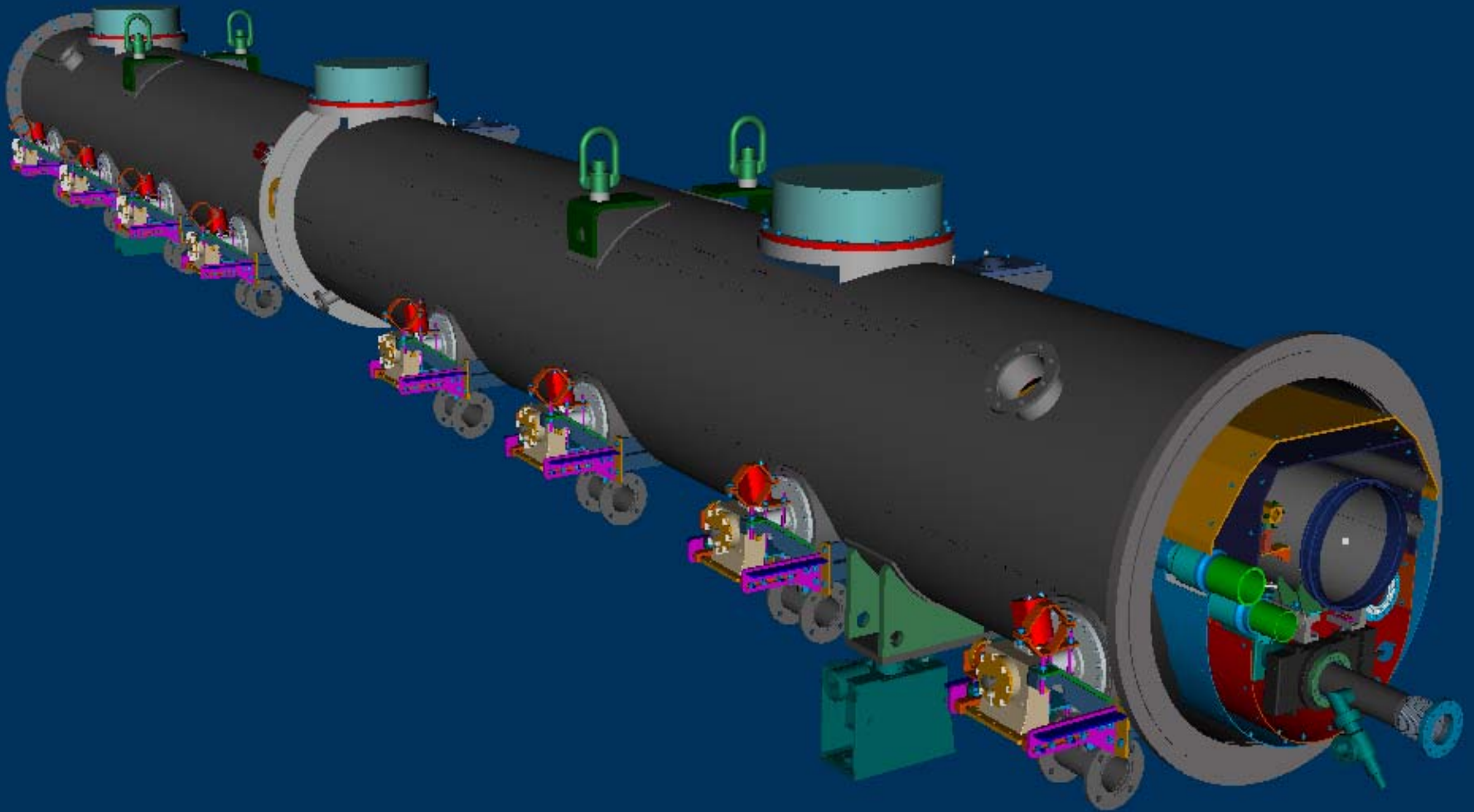

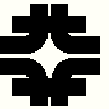

- Indian scientists have been collaborating at CERN for decades.
- Its participation and contribution to LHC has given India an Associate Member State status with CERN.
- India has build accelerator and detector components for LHC/CMS.
- India also participates in experiments at KEK and DESY.

20 Years of Indo-US HEP Collaboration



- Indian Scientists have collaborated in a High Energy Physics Experiments from early 80's at Fermilab and other US laboratories.
- At Fermilab the collaboration started with Fixed Target Experiment and has now extended to D0 and Accelerator.
- Argonne National Laboratory has collaborated with India on Superconducting cavity development.
- Six Institutes from India collaborates on the STAR experiment at BNL.
- Many US laboratories have worked with Indian laboratories
- Indians are on staff of every US laboratories, universities and major US industries.

- **Several Indian accelerator laboratories are in construction and/or operation today**
 - VECC
 - RRCAT
 - BARC-TIFR
 - IUAC
- **India collaborates on accelerators construction and operation around the world, including Fermilab and CERN.**
- **India has plans in place to develop modern accelerator for applied research and energy production R&D.**
 - Radioactive Ion Beam Facility
 - Spallation Neutron Source
 - High Intensity Proton Linac for Accelerator Driven Sub-critical Reaction

ATOMIC ENERGY ESTABLISHMENTS

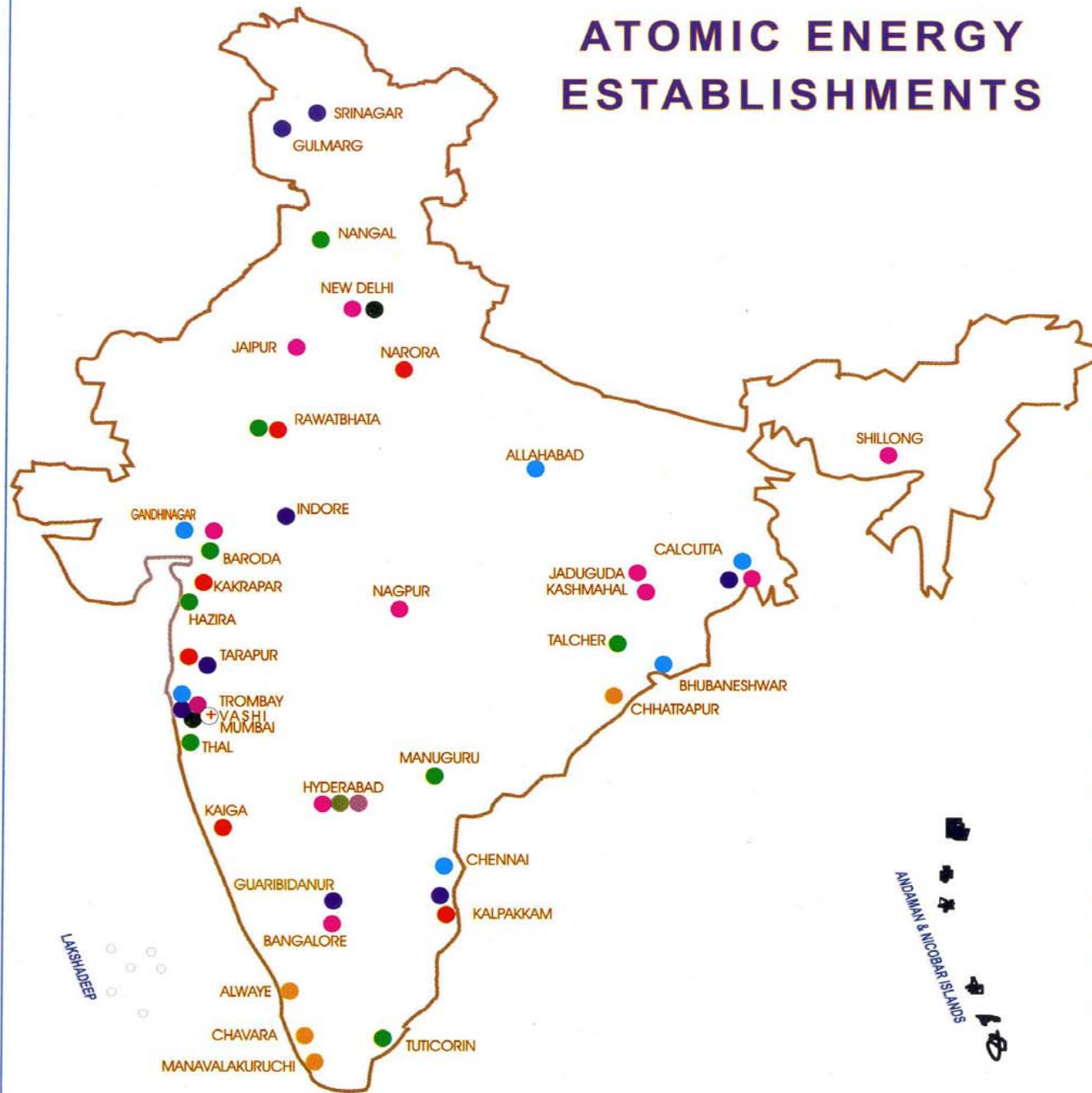

- DEPT. OF ATOMIC ENERGY SECRETARIATE MUMBAI & BR. SECRETARIATE, NEW DELHI
- VARIABLE ENERGY CYCLOTRON CENTRE, CALCUTTA
- BHABHA ATOMIC RESEARCH CENTRE TROMBAY, TARAPUR, SRINAGAR, GULMARG, GAURIBIDANUR
- INDIRA GANDHI CENTRE FOR ATOMIC RESEARCH, KALPAKKAM
- CENTRE FOR ADVANCED TECHNOLOGY, INDORE
- NUCLEAR FUEL COMPLEX, HYDERABAD
- HEAVY WATER PLANTS NANGAL, RAWATBHATA, BARODA, TALCHER, TUTICORIN, MANUGURU, THAL, HAZIRA
- BOARD OF RADIATION & ISOTOPE TECHNOLOGY, TROMBAY, VASHI.
- NUCLEAR POWER STATIONS, TARAPUR, RAWATBHATA, KALPAKKAM, NARORA, JADUGUDA, KANKRAPAR & KAIGA PROJECT.
- ELECTRONICS CORPN. OF INDIA LTD., HYDERABAD.
- INDIAN RARE EARTHS LTD. ALWAYE, CHAVARA, MANAVALAKURUCHI, CHHATRAPUR
- TATA INSTITUTE OF FUNDAMENTAL RESEARCH, MUMBAI
- INSTITUTE FOR PLASMA RESEARCH, GANDHINAGAR
- SAHA INSTITUTE OF NUCLEAR PHYSICS, CALCUTTA
- INSTITUTE OF PHYSICS, BHUBANESHWAR
- INSTITUTE OF MATHEMATICAL SCIENCES, CHENNAI.
- MEHTA RESEARCH INSTITUTE, ALLAHABAD
- ATOMIC MINERALS DIVISION HYDERABAD, NAGPUR, BANGALORE, JADUGUDA, BARODA, JAIPUR, NEW DELHI, KASHMAHAL, CALCUTTA, SHILLONG.
- + TATA MEMORIAL CENTRE, MUMBAI

224 CM VARIABLE ENERGY CYCLOTRON AT VECC

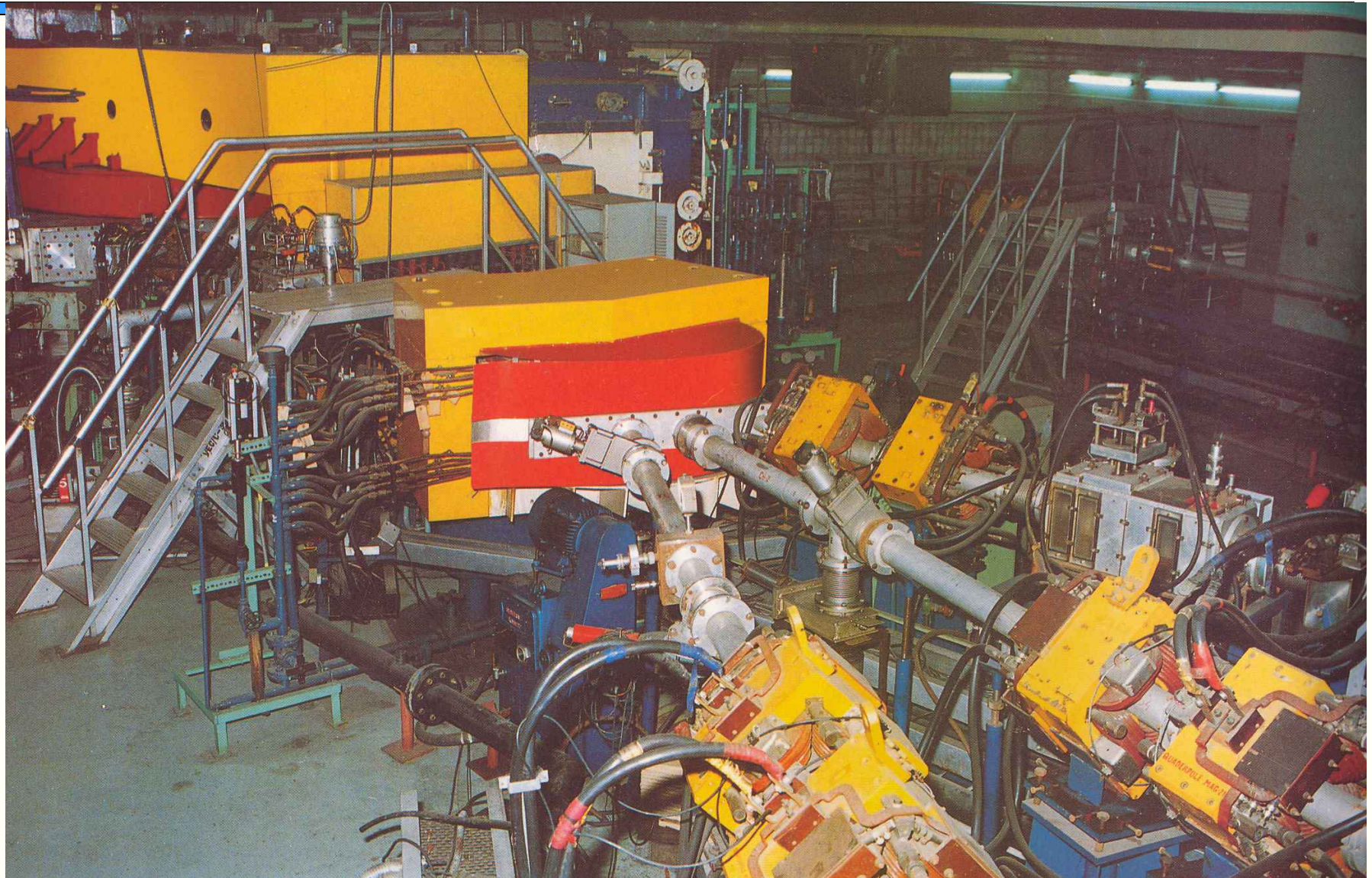

ION SOURCE AND ANALYZING MAGNET : VECC



CYCLOTRON MAGNET VECC

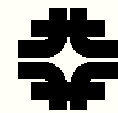

Fermilab

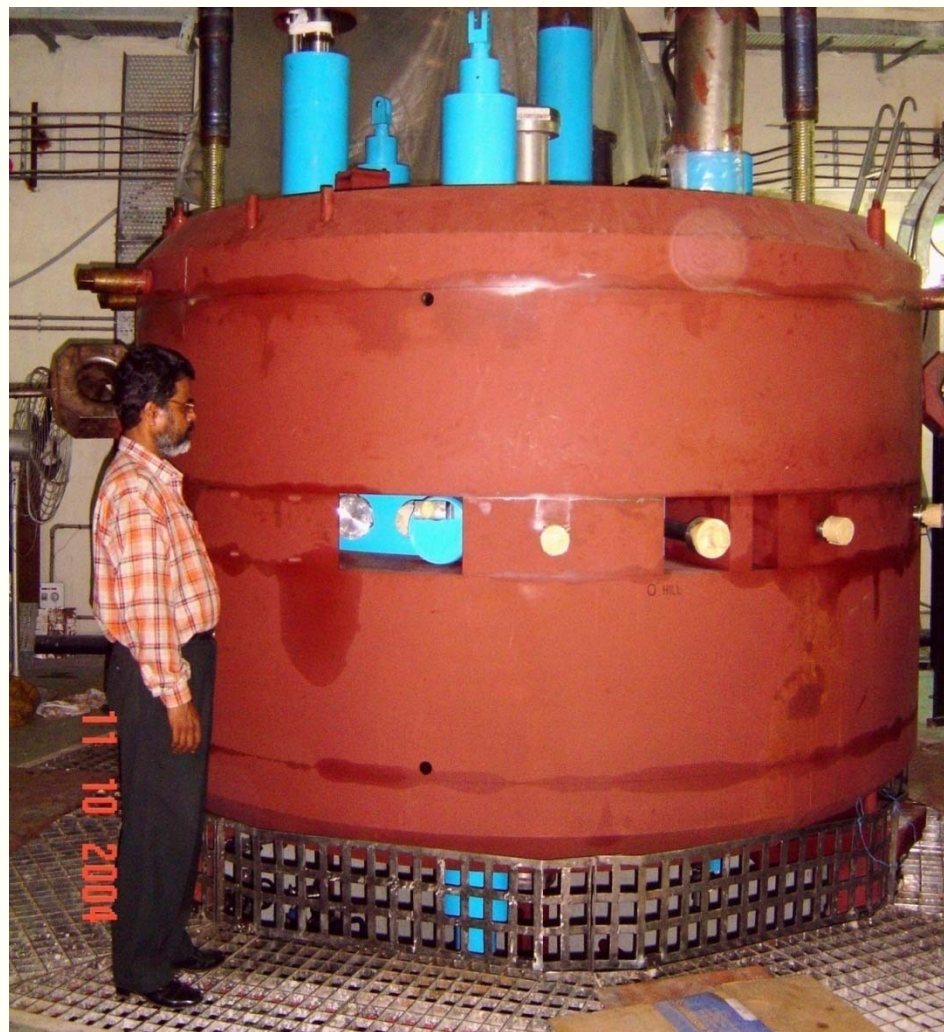

Medical Accelerator: VECC

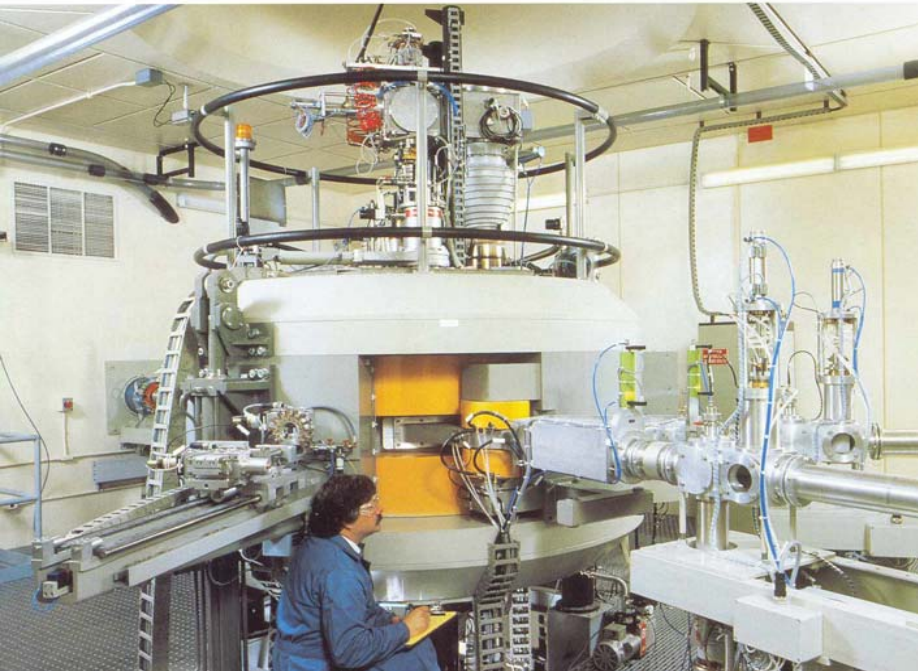

Medical Cyclotron

4 MV MEDICAL LINAC JEEVAN JYOTI - 2



RRCAT Accelerator Complex

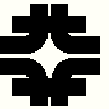

Fermilab

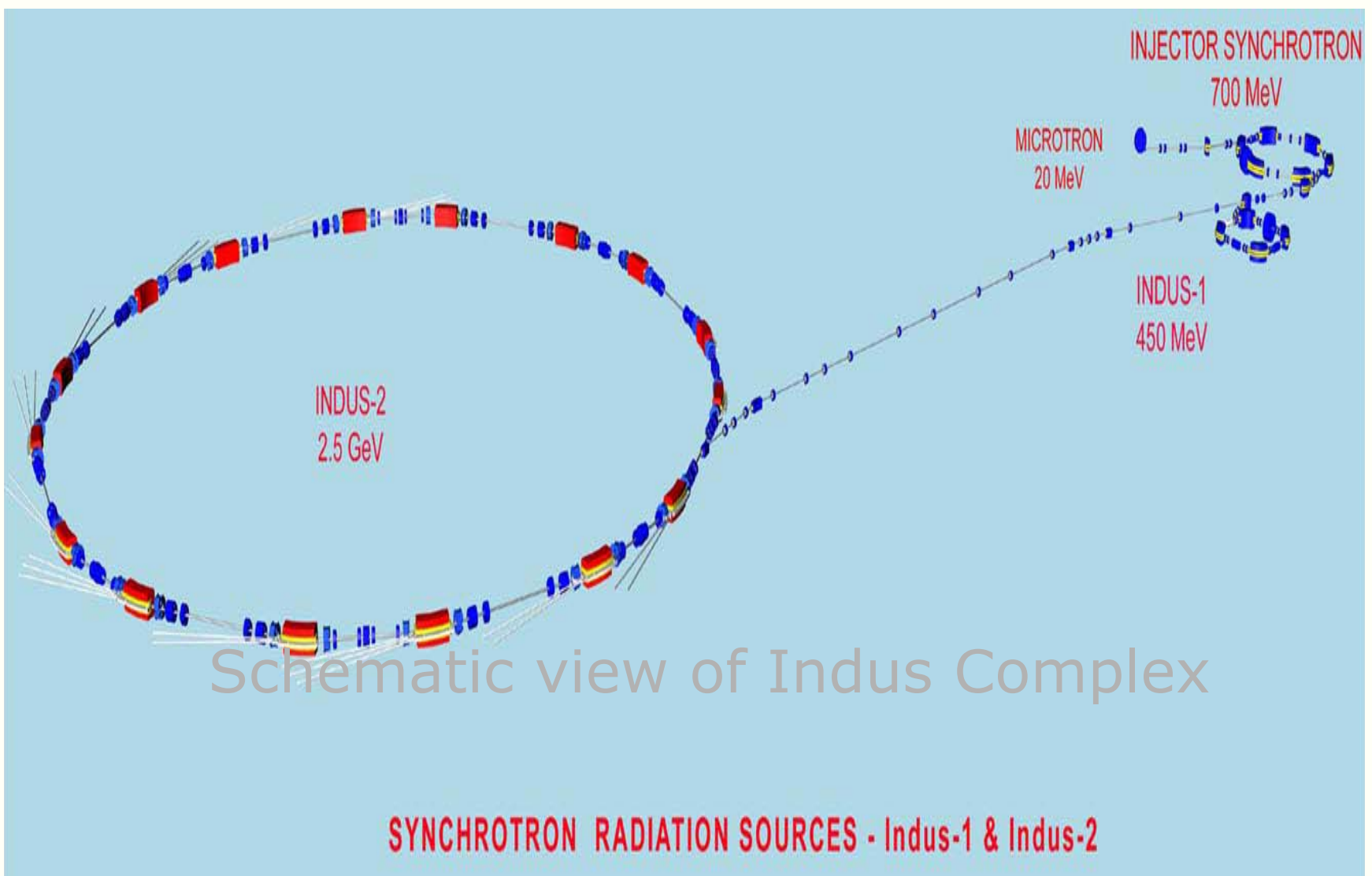

RRCAT: Microtron



RRCAT: Booster

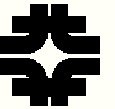

Fermilab

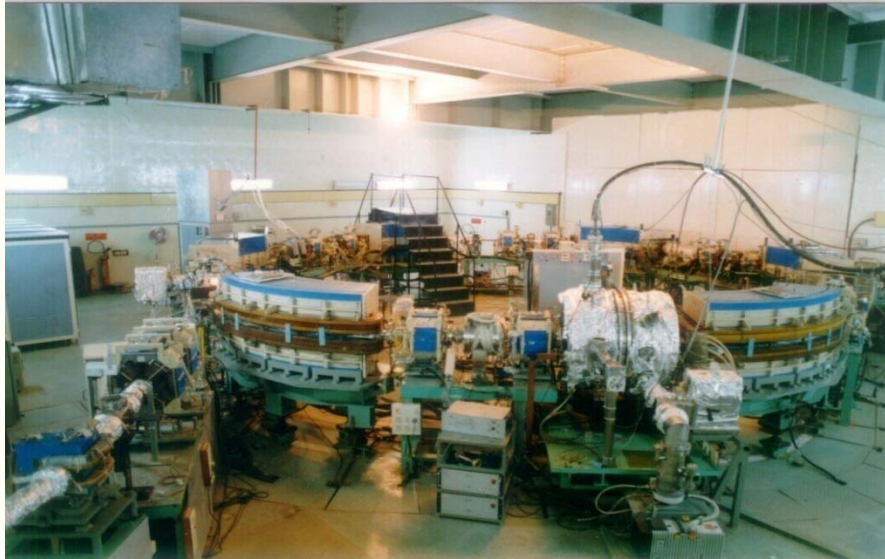

Magnet for Indus-2 made by India



Fermilab

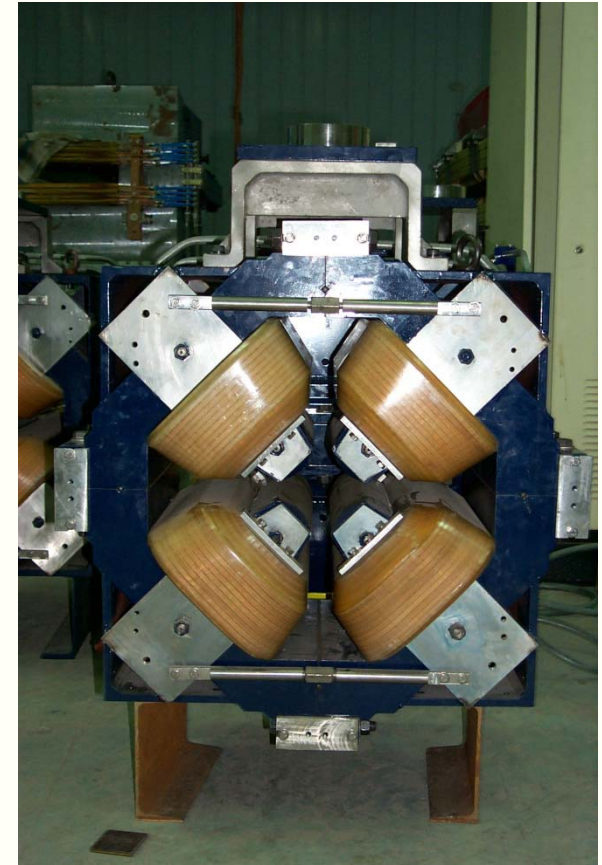

Dipole Chambers Build in India



- ❖ **Material: Aluminium alloy A5083-H321**
- ❖ **Two beam ports at 5° and 10° in each dipole chamber**
- ❖ **Additionally, port at 0° is also provided in five dipole chambers for insertion devices**

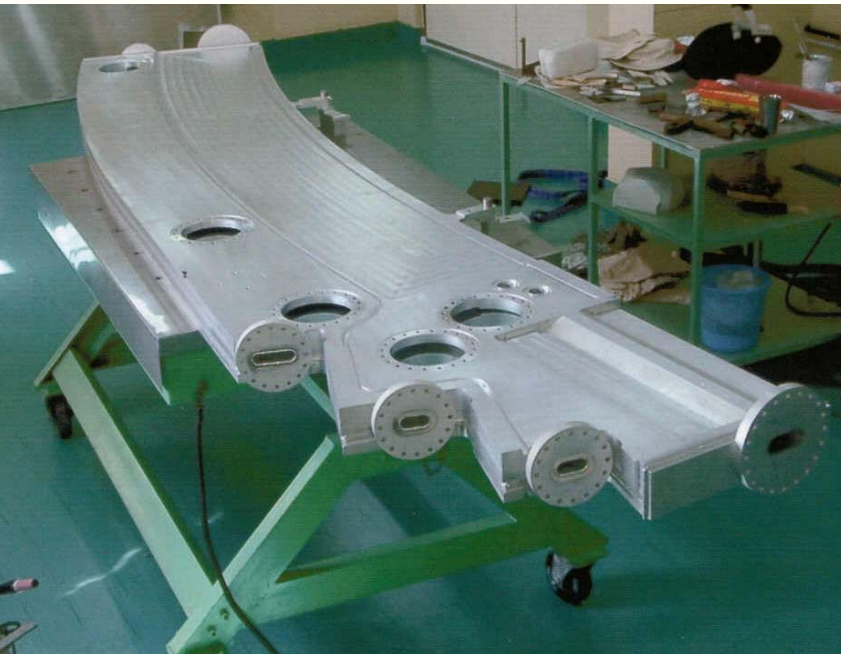

Indus-II

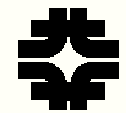

Fermilab



Indus-2 Ring in the Tunnel



RF Cavities installed in Indus-2 Ring



01/15/08 Long Straight Section LS-6 Assembly JAS 2008



Transport Line-3 Joining on to Indus-2 27

RRCAT: Application Accelerator

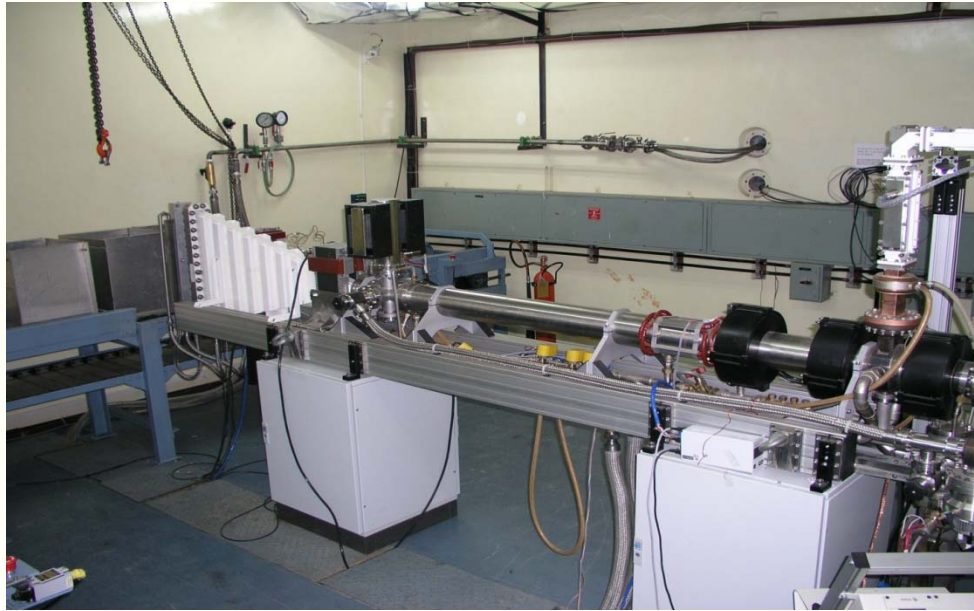

10 MeV Electron
Accelerator for Radiation
Processing Applications

Microtron based prototype
irradiator for life science
related work

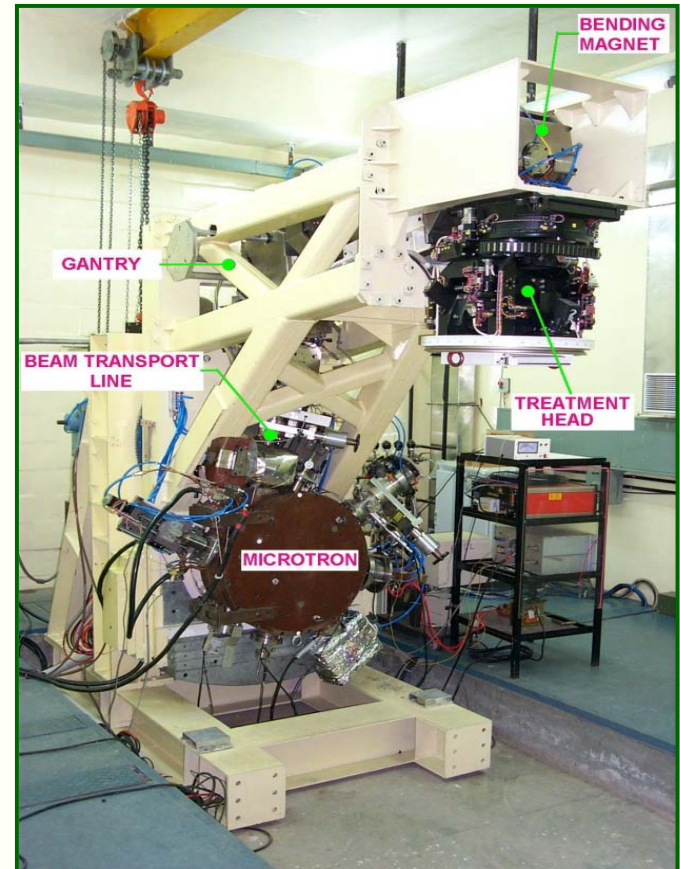

India: LHC Collaboration

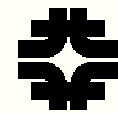

Fermilab

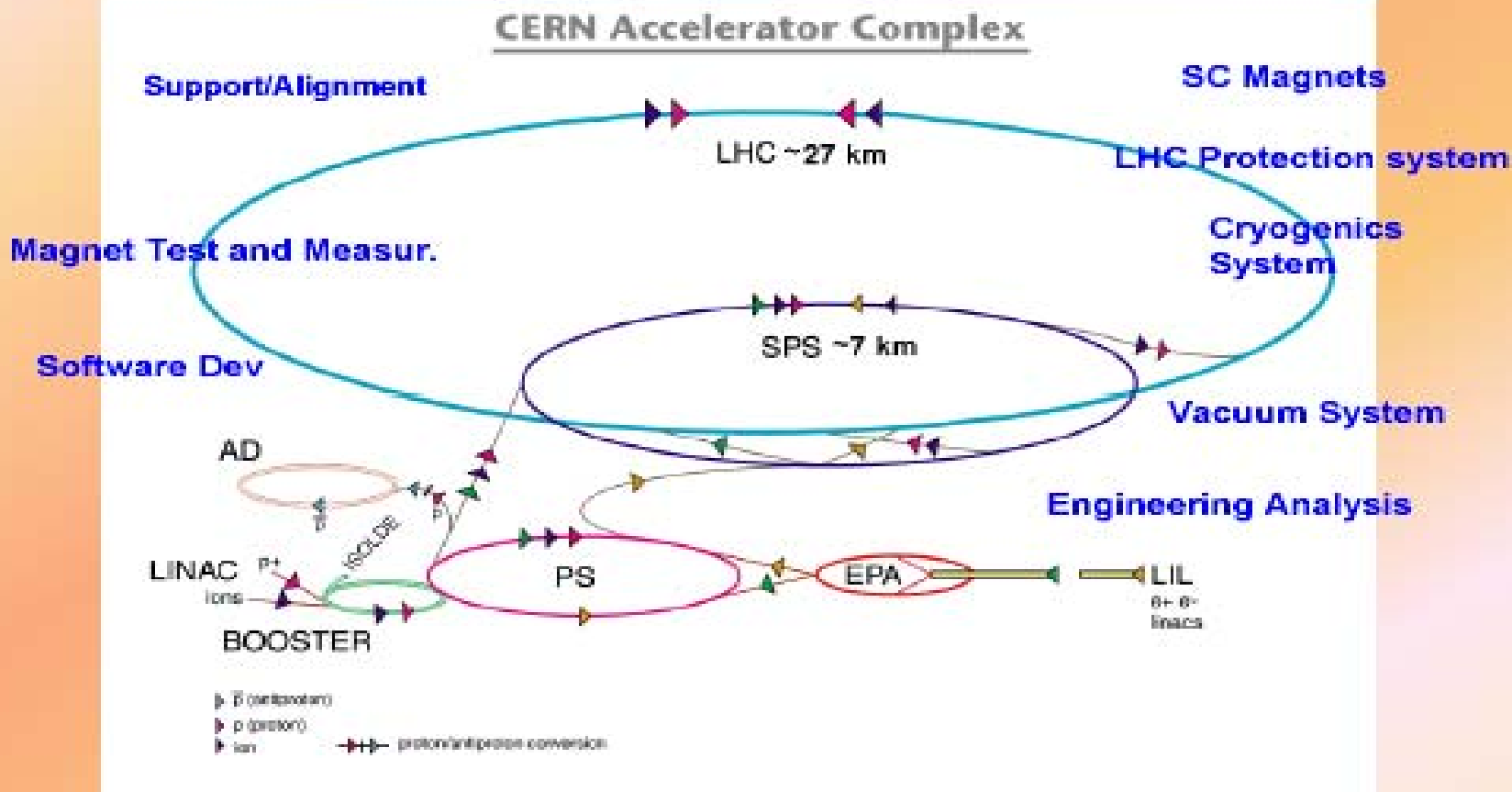

Indian Contributions – LHC domains

LHC Contributions



7080 Nos. Magnet Positioning System Jacks



MCS (1146 Units) & MCDO (616 Units)



Magnetic measurements teams- ~100 Man-years



5500 Nos. Quench Heater Power supplies(QHPS)
01/15/08



1435 Nos. Local Protection Units
JAS 2008



A part of DAE's contributions installed in LHC Tunnel at CERN

BARC-TIFR Heavy Ion Accelerator



Accelerator layout

Pelletron

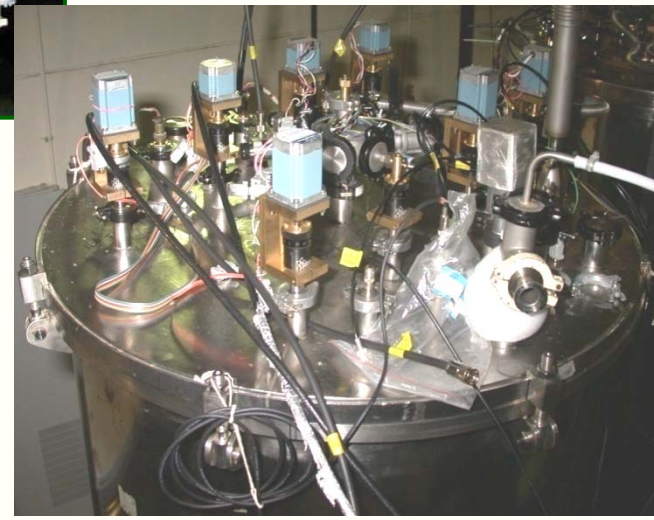
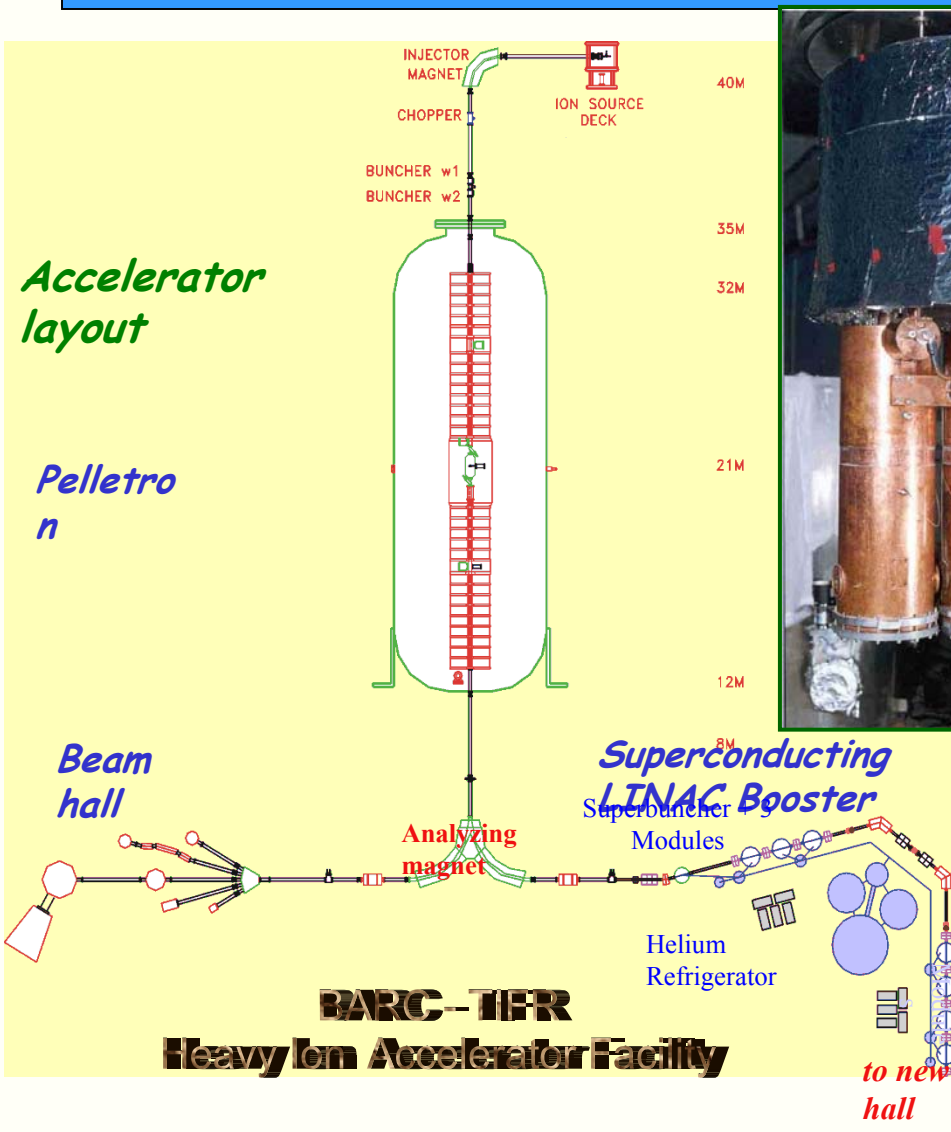



Cryostat modules housing the resonators with liquid He distribution box

SCRF Facility at IUAC



Fermilab



Electro-Polishing



BCP

Electron Beam
Welding Machine



SCRF Cavity Build at IUAC

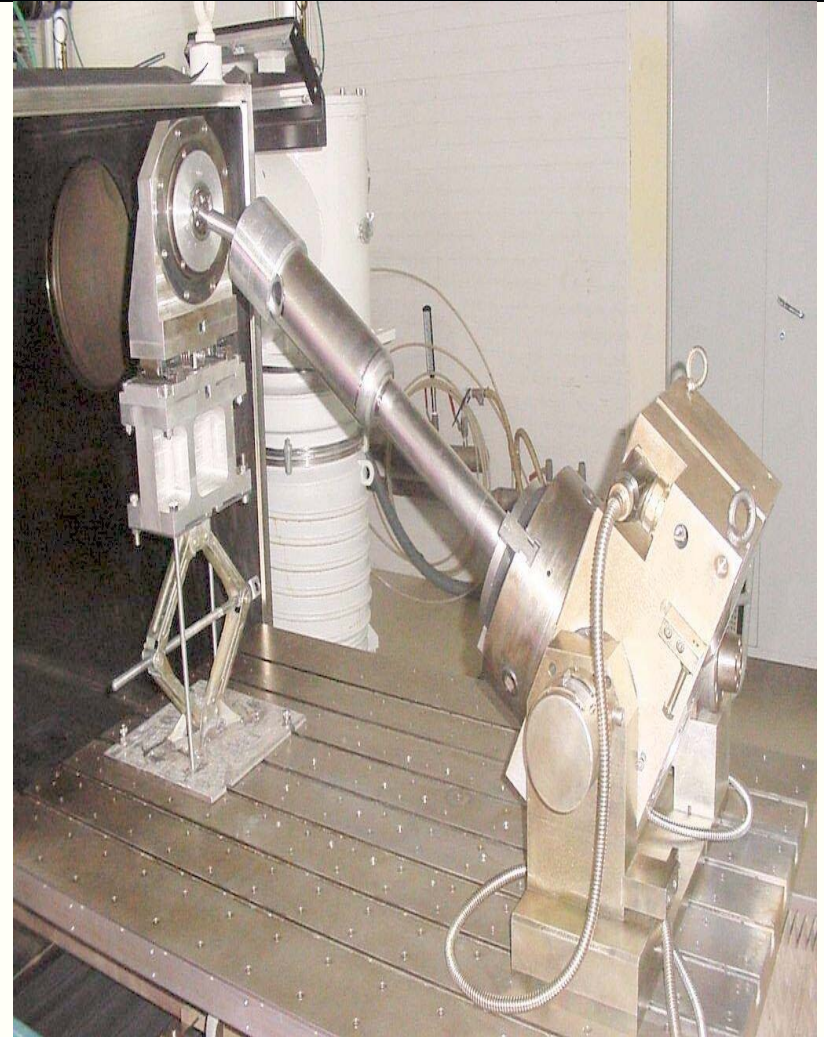
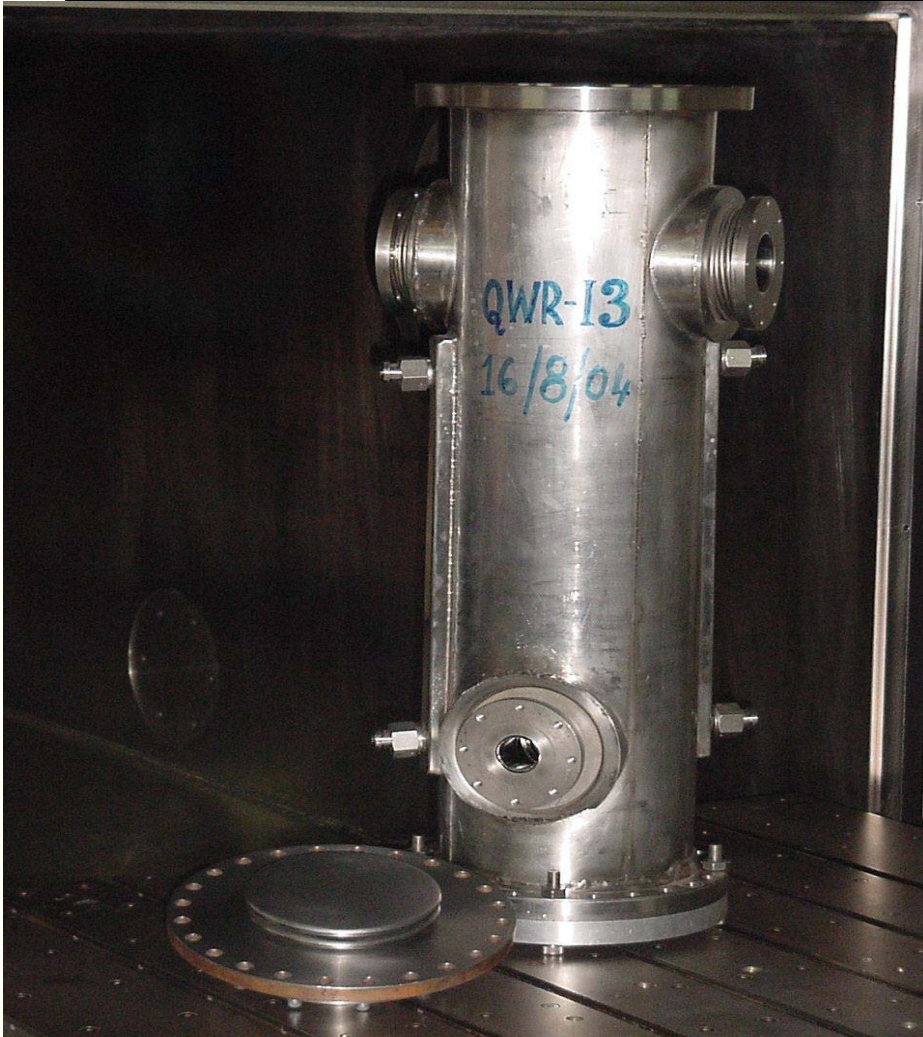

One of the two fully indigenously fabricated resonators at NSC along with its slow tuner bellows.

IUAC: SRF Cavity

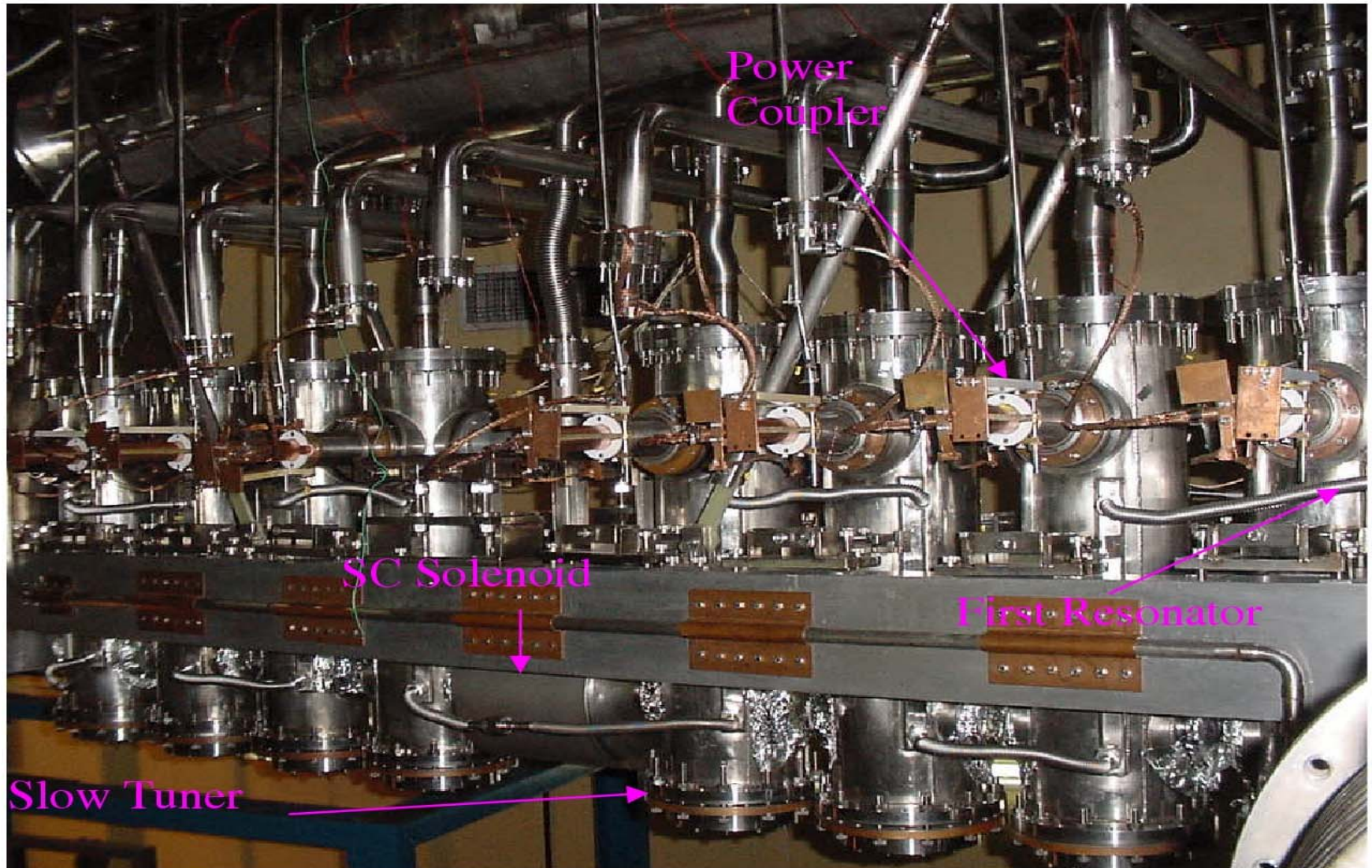

Linac Module with Beam Line and Cryogen distribution lines



Energy Gain as designed

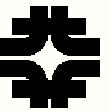

Fermilab

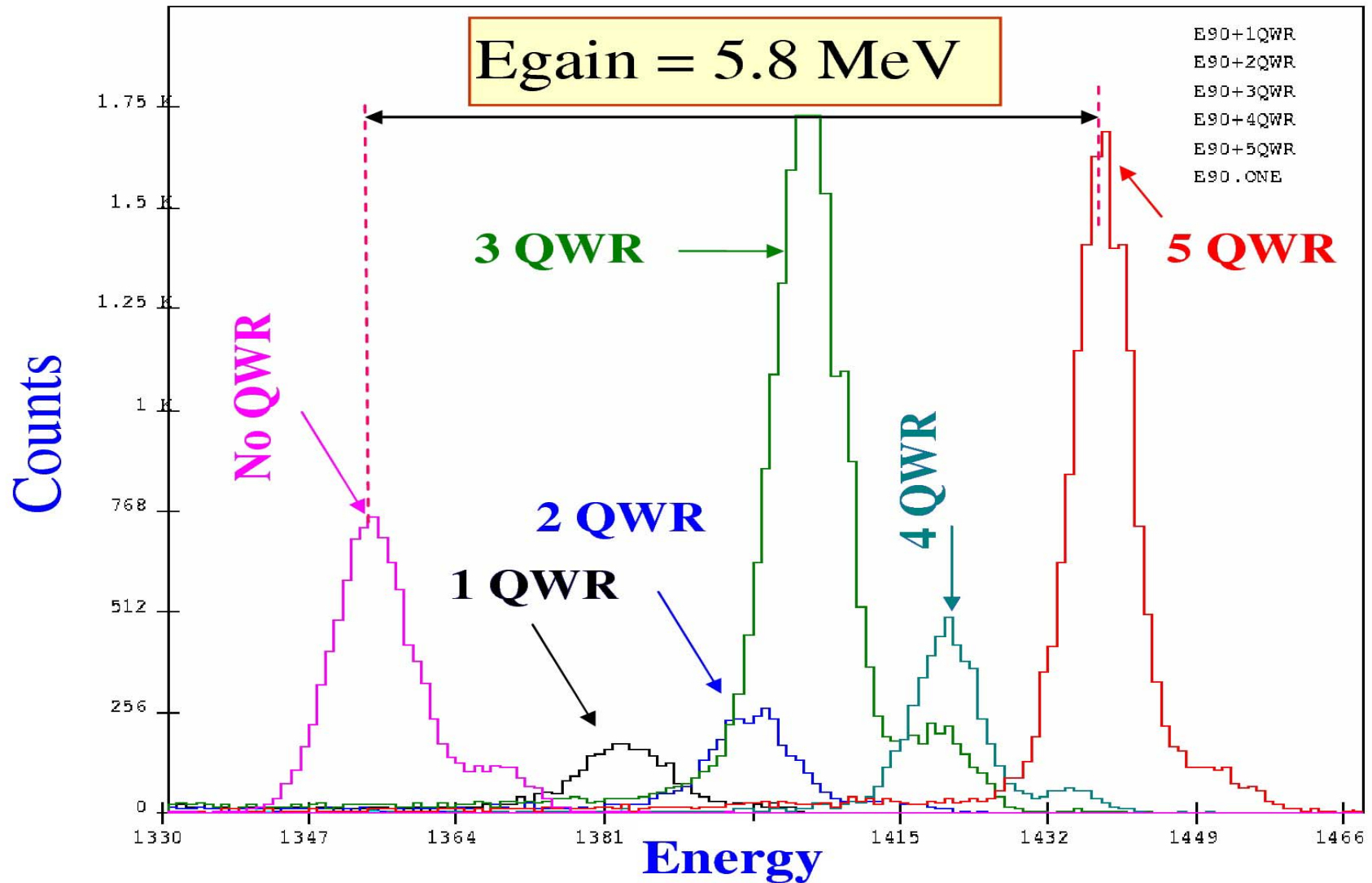

Scheme for Accelerator Development for ADS

Normal Conducting

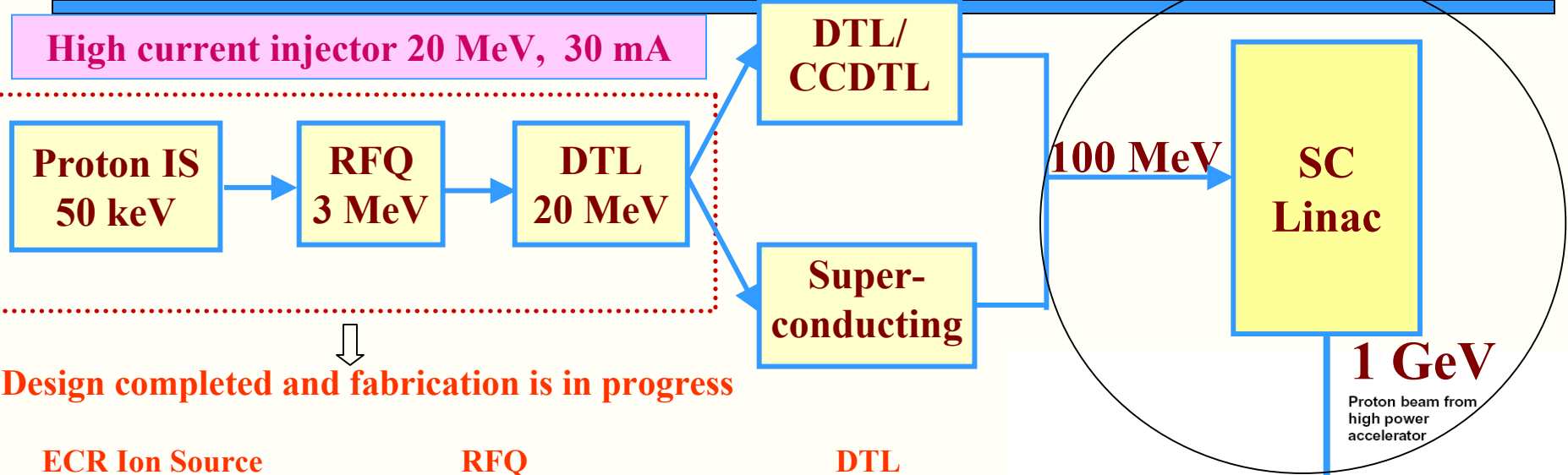

Design completed and fabrication is in progress

ECR Ion Source

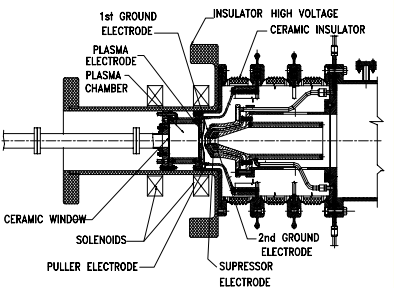

RFQ

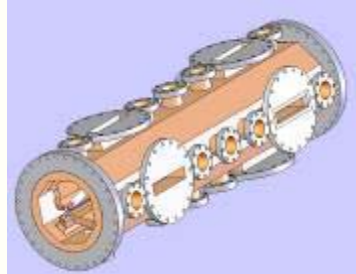

DTL

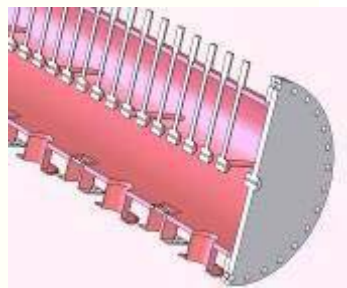

Beginning Cell

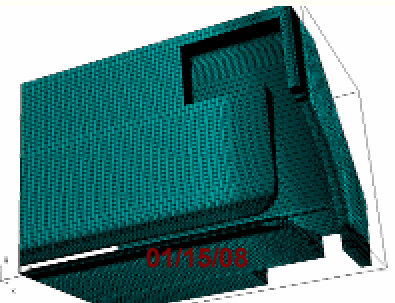

Coupling Cell

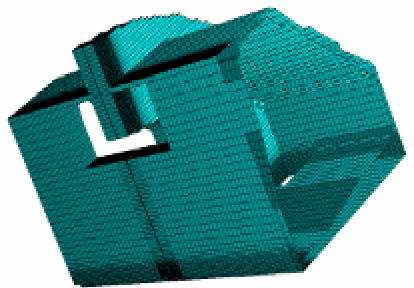

Elliptical SC Cavity

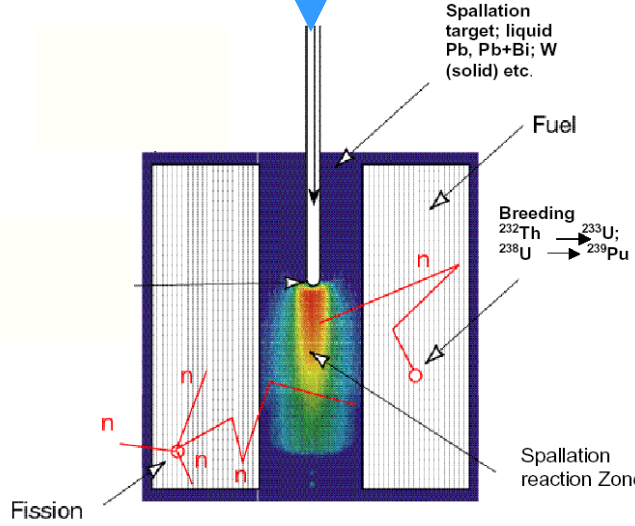
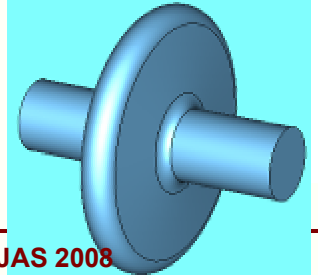

Material R&D at RRCAT



Results on BCP Samples of Nb from Fermilab. (Large Grain Nb from Jlab also studied)

Sample # 16
Avg grain size
~ 30-35 Micron

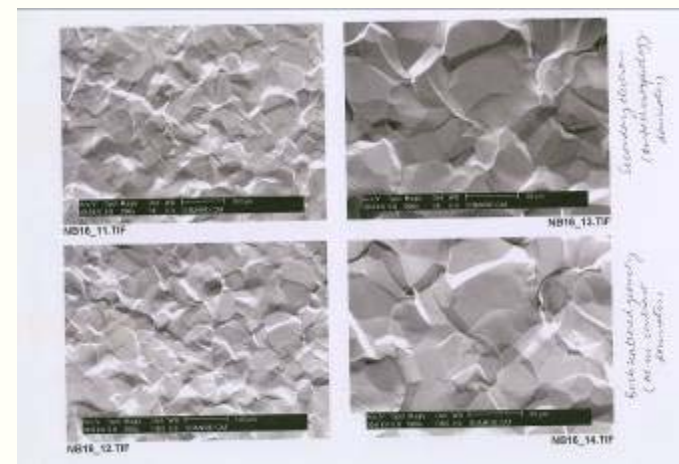
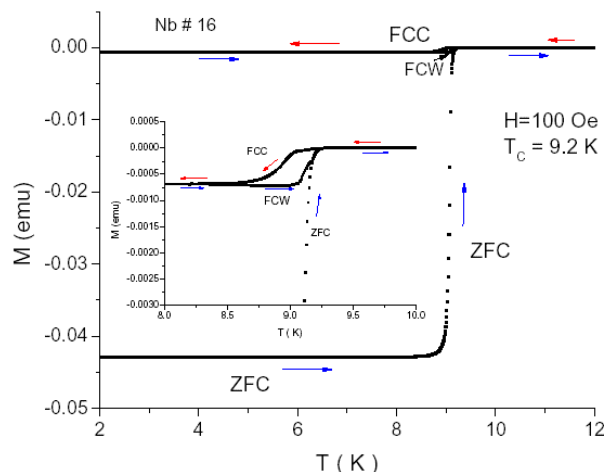

Sample # 17
Avg grain size
~ 40-45 micron

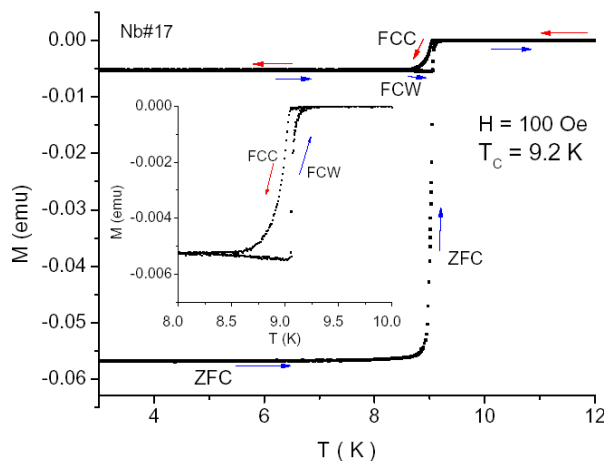

RRCAT: Cavity RF Simulation



1.3 GHz Cavity

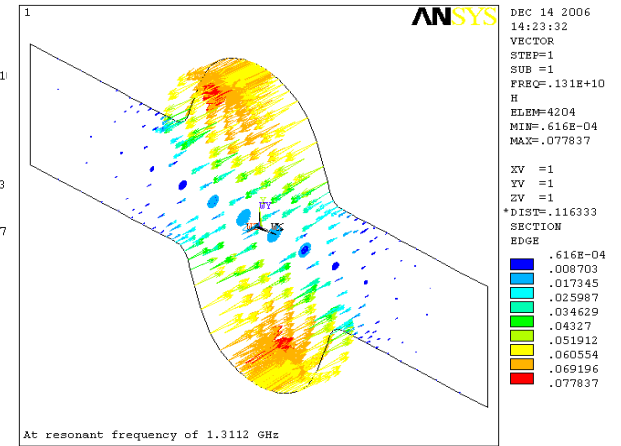
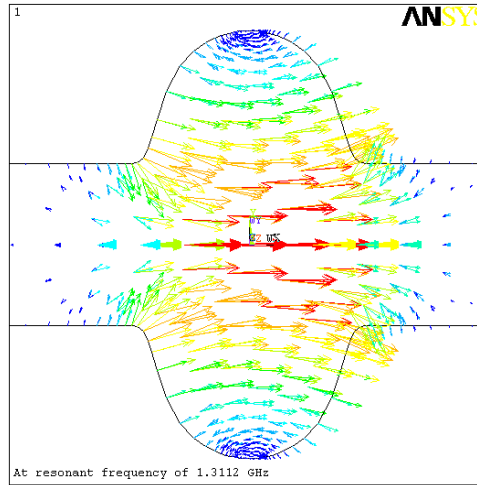
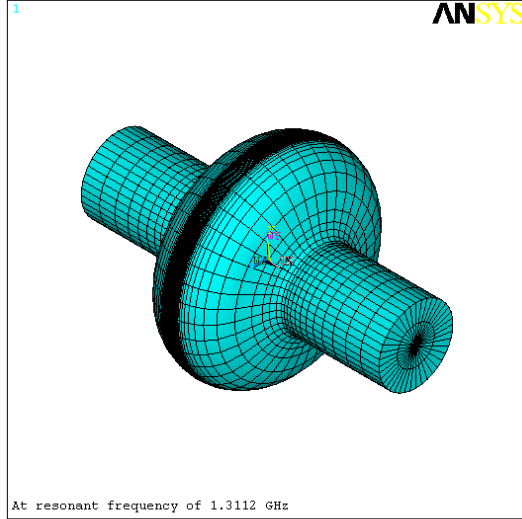

31.6 MHz Indus-1 Cavity

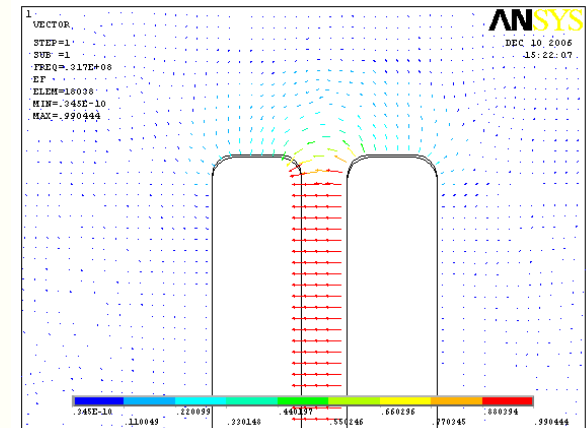
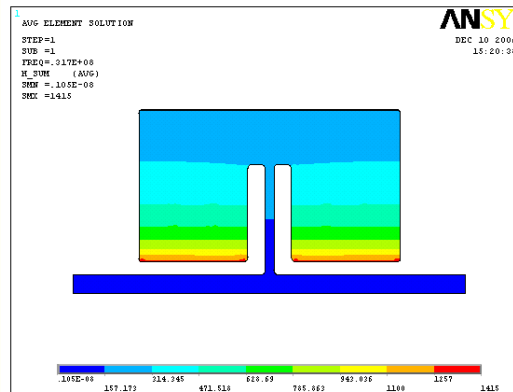
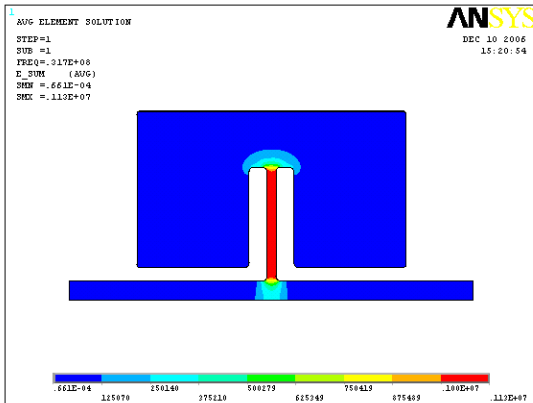

Indian Laboratories work on ILC



- **There exists a collaboration between Fermilab, SLAC and Indian laboratories to work on the Superconducting Main Linac Development.**
- **RRCAT and BARC are developing infrastructure for the development of the Indian accelerator program, while collaborating on international accelerators.**
- **The present focus is on Design for manufacturing of the Main Linac SRF components.**
 - **Tooling design and improvements**
 - **Cavity manufacturing value engineering**
 - **Cryomodule design and value engineering**
 - **Design and fabrication of cavity tuners.**
- **Indian engineering team stationed at RRCAT and BARC have made valuable contribution to the ILC program.**

Some Highlights of Indian Contribution

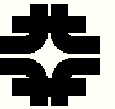

Fermilab

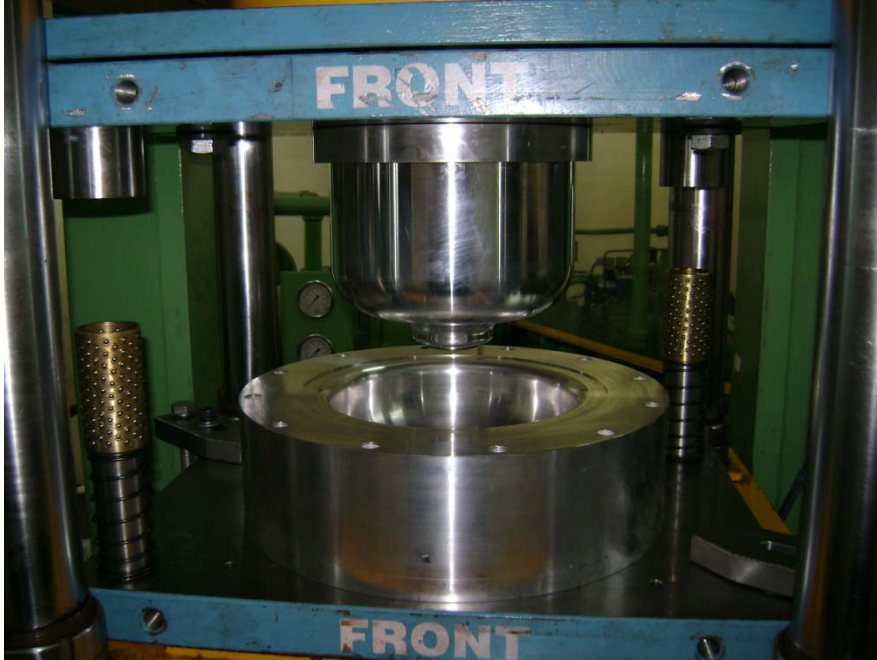

Cavity Fabrication tooling



Highlights

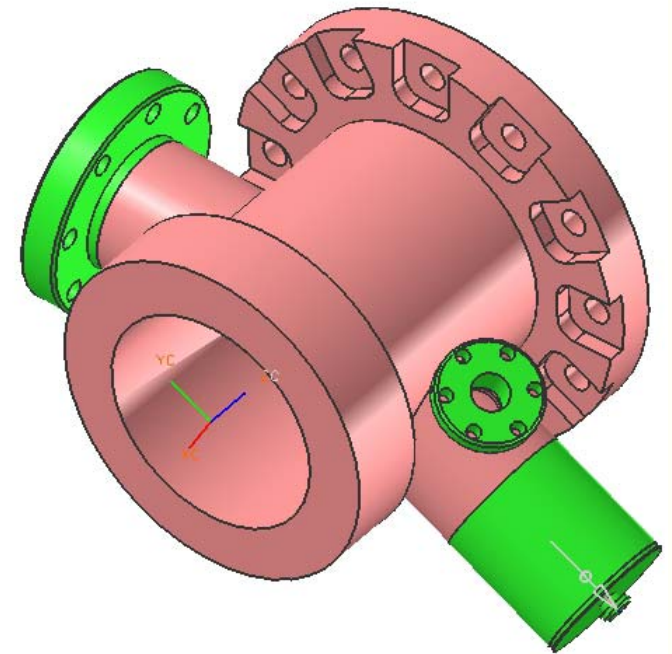
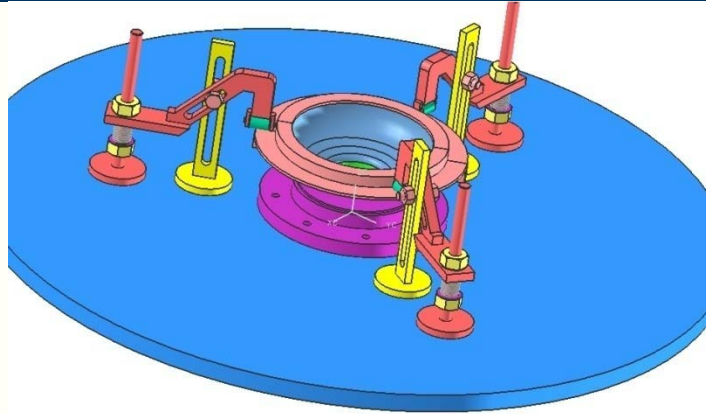
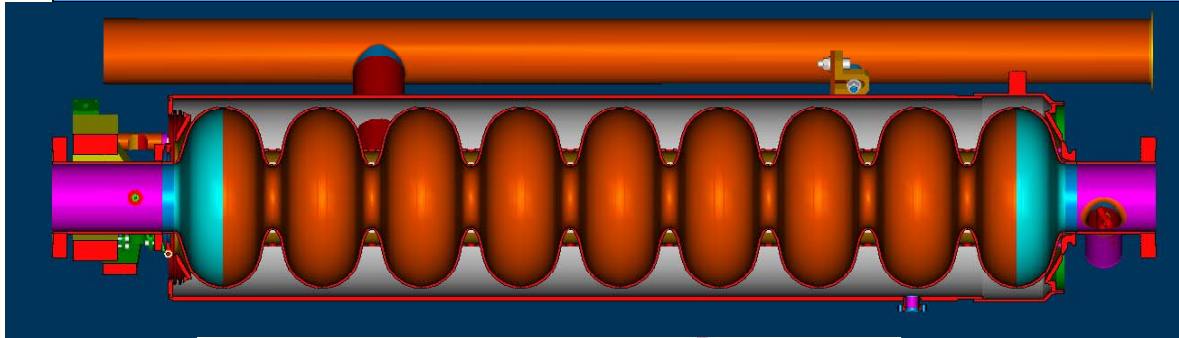

There is a possibility of significant cost saving if we could just implement these two changes suggested by RRCAT engineering team.

Summary



- The opportunity in accelerator science and technology development is the best ever both in India and abroad.
- The R&D on several international accelerator is progressing with India as an equal partner.
- Indian domestic accelerator program is developing with several accelerators under commissioning.
- Future accelerator plans in India is even more challenging.
- Indian scientific staff continues to make valuable contributions to International accelerator program.